

OpenTracker User's Manual

PCB Revision 4

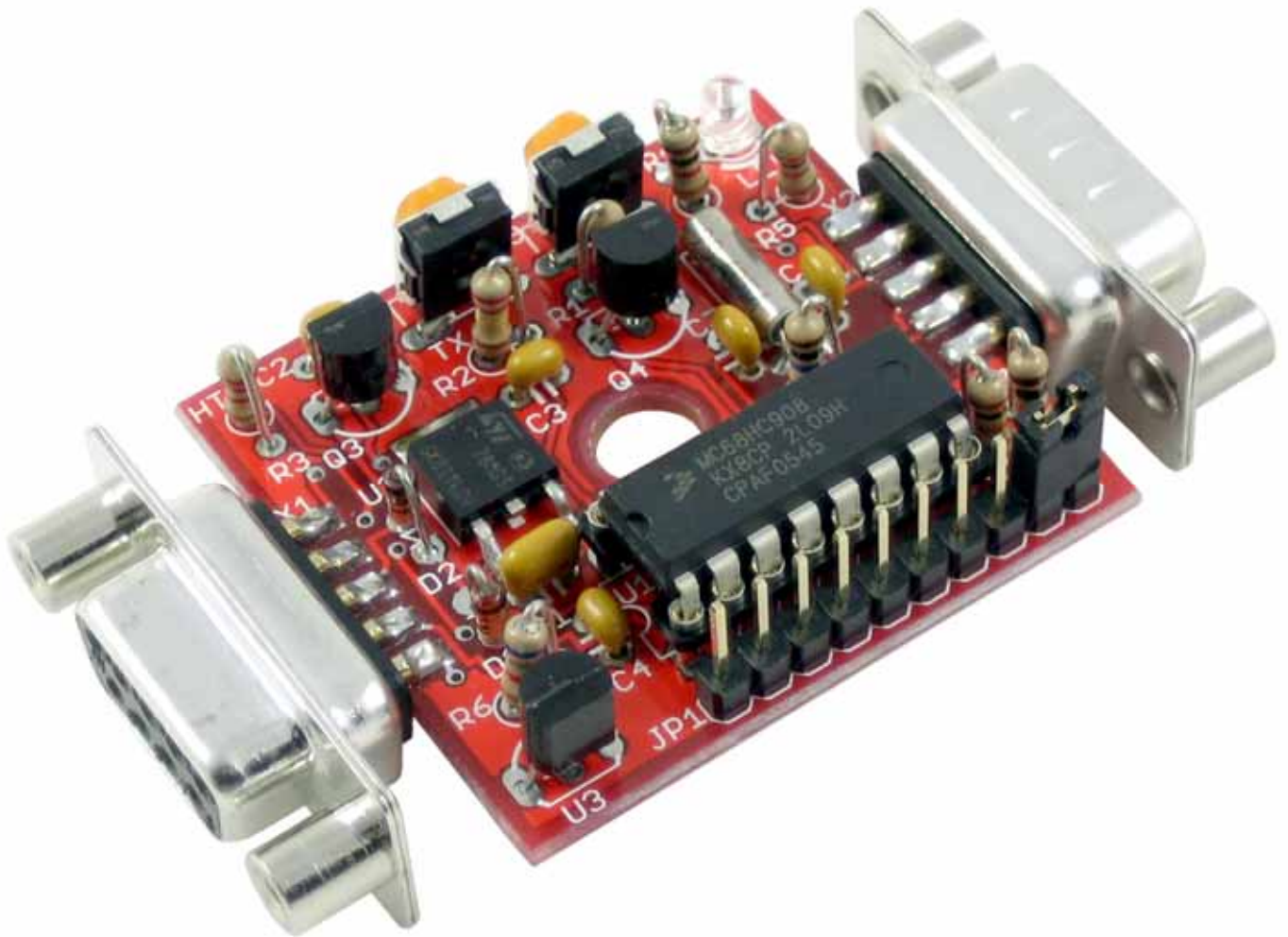

1. Introduction

The OpenTracker is a simple, low-cost amateur radio data encoder capable of generating 1200 or 300 baud AX.25 packets using both APRS™ and OpenTRAC protocols, as well as PSK31 text beacons. It can be connected to a GPS receiver to report position, course and speed, time, and altitude, and will also report telemetry from its onboard temperature and voltage sensors. With its expansion connector and ease of reprogramming, the device can be adapted to a wide variety of tasks.

Changes

PCB Revision 4 includes significant changes from previous hardware revisions. While the firmware features and configuration options remain the same, the pin header configuration and power specifications have changed. Revision 4 incorporates a larger voltage regulator capable of supplying enough current to power many popular 5-volt GPS receivers without requiring a heat sink.

Acknowledgements

The OpenTracker is far from being the first device of its type, and owes much to those that came before – in particular, John Hansen’s GPS-E firmware and its TAPR PIC-E hardware, Steve Bragg’s HamHUD, and Byon Garrabrant’s very successful TinyTrak series. Lessons learned from all of these devices have contributed to the design of the OpenTracker. The OpenTracker is very similar in physical layout to the TinyTrak3 (in its ‘trimmed’ version), and identical in connector configuration, allowing enclosures and cables to be used interchangeably. Despite their similarities, though, the two devices have very different processor architectures, different digital-to-analog conversion systems, and entirely unrelated firmware. The SmartBeaconing™ algorithm used by the OpenTracker was originally developed by Tony Arnerich, KD7TA, and Steve Bragg, KA9MVA. APRS™ is a trademark of Bob Bruninga, WB4APR. Brian Riley, N1BQ, and Keri Morgret, N6TME, contributed to this manual.

Table of Contents

1. Introduction	2
2. OpenTracker Assembly Notes	4
3. Connector Pin Assignments	6
a. General	7
b. Receive Adjustment	7
c. Transmit Adjustment	7
d. LED Blink Codes	8
e. Configuration Program	8
f. Main configuration window	9
5. Installing New Firmware	14
6. Weather Station Operation	15
7. Telemetry Operation.....	16
8. OpenTracker Circuit Details.....	17
Theory of Operation	18
Appendix A – Test Procedures	20
a. Measurements	20
Appendix B – APRS symbol tables.....	21
Appendix C – Common Modifications	23

2. OpenTracker Assembly Notes

Table 1 – Parts List

Part	Description	Notes
U1	MC908KX8 MCU with socket	Reference notch faces left
U2	78M05 Voltage Regulator	Install first
U3	LM335Z	Align to silkscreen outline
R1, R7	10 K resistor	Brown-Black-Orange
R2	220K resistor	Red-Red-Yellow
R3	2.2K resistor	Red-Red-Red
R4	1K resistor	Brown-Black-Red
R5	3K resistor	Orange-Black-Red
R6	6.8K* resistor	Blue-Gray-Red
R8, R9	10K potentiometer	Align pins to holes
R10	10M resistor	Brown-Black-Blue
R11	20K resistor	Red-Black-Orange
JP1	10-pin header	Single row .100 pins
C1	0.33uF capacitor	Yellow with “334” marking
C2-C4	0.1uF capacitor	Yellow with “104” marking
C6, C7	18pF capacitor	“180” or “180j” marking
Q3, Q4	2N7000 transistor	Align to silkscreen outline
D1-D2	1N914 or 1N4148 diode	Black band denotes cathode
LED	Red LED	Short lead faces toward R4
X1	DB9 Connector - female	Left edge of board
X2	DB9 Connector - male	Right edge of board
Y1	29.4912 MHz crystal	Bend down to PCB before soldering

* A 6.2K resistor (Blue-Red-Red) may be substituted for R6

The OpenTracker kit requires basic to intermediate level soldering skills. You will need a low-wattage soldering iron, wire cutters, and solder. Rosin core solder is recommended – never use acid core solder for electronics.

Review the parts list and identify the components you received. If any are missing or damaged, contact support@n1vg.net for replacements. Don't worry if your kit includes extra resistors or other parts not listed above – these are provided for modifications and alternate versions of the kit.

U2 is a surface mount device and should be installed first for ease of soldering. Apply a small drop of solder to one pad and keep it melted while you align the part. Solder the other leg and the metal tab at the top, making sure that the solder forms a good junction between the tab and the circuit board for proper heat transfer.

The DB9 connectors should be soldered next. Note that the male connector is installed on the right side, and the female connector is installed on the left. The rest of the parts may be installed in any order.



The 16-pin DIP socket for the microcontroller, U1, is optional, but recommended to facilitate replacement. Resistor R3 is used for PTT keying with certain types of handheld radios. For other radios, particularly mobiles and Kenwood handhelds, this resistor may be omitted. See section 4 for more information.

Pay close attention to component polarity. Diodes D1 and D2 have their cathode ends marked with a black band. This corresponds to the line at the pointed end of the symbol shown for these parts on the silkscreen. The LED should have its short lead and/or flat edge installed to the left, facing D1. The microcontroller, U1, has a reference notch on one edge that should face left as shown in the diagram below.

To straighten U1's pins prior to insertion, place one row of pins on a hard, flat surface. Hold the IC by the edges and gently roll it until the pins reach the correct angle. Repeat for the other row, and insert the IC into its socket gently, making sure that each pin is aligned with its hole.

Install all diodes and resistors vertically. One lead should be bent around parallel to the component. For resistors, the body of the component is installed over the pad indicated with a circle on the silkscreen.

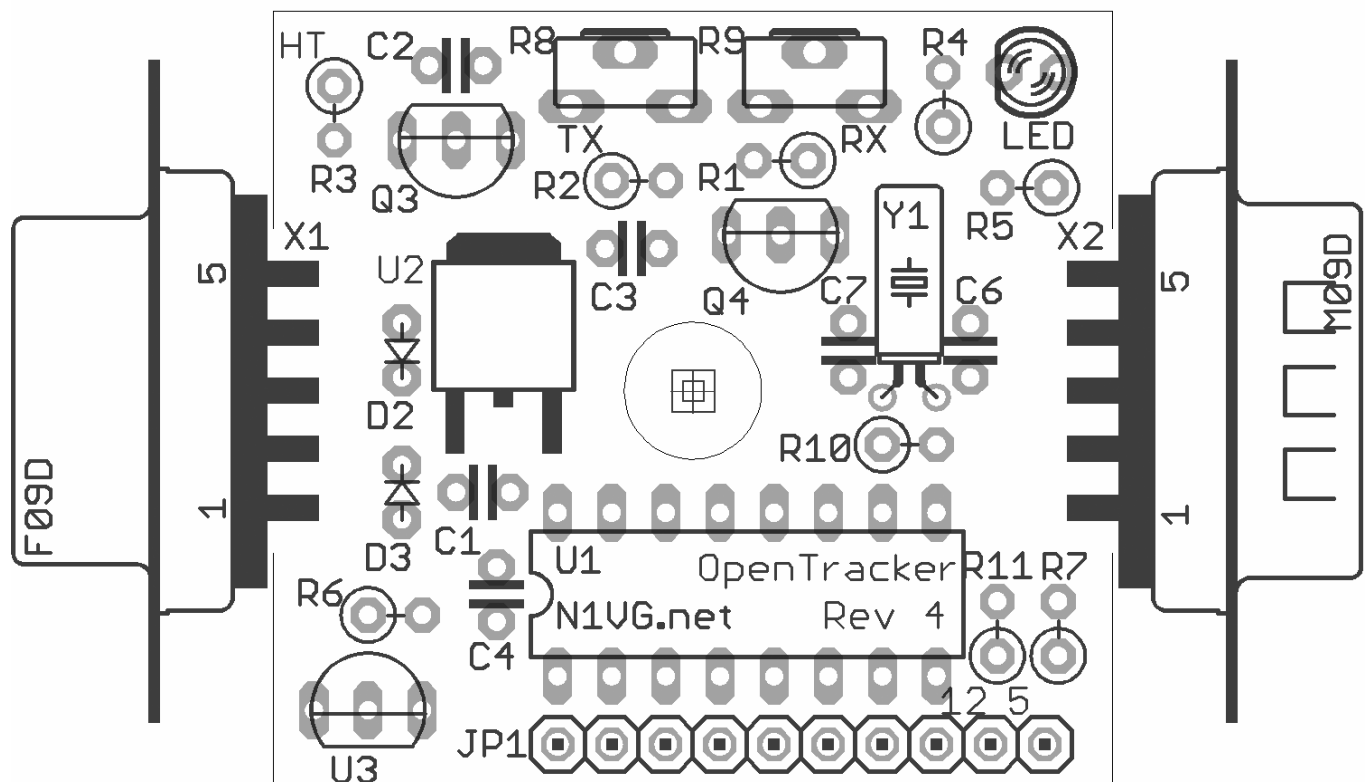

3. Connector Pin Assignments

Table 2 – Pin Header 1 (JP1)

Pin	Designator	Notes
JP1	PTT Input or Relay Out	See note #1
JP2	Ground	
JP3	Jumper	Usually used to switch configurations
JP4	IRQ	See Note #2
JP5	ADC0	On-board temperature sensor
JP6	ADC1	On-board divider provides 1/3 V_{in}
JP7	ADC2	Extra ADC input or 1-wire data bus
JP8	V_{in}	6.7 to 35 VDC
JP9	V_{ext}	(see Note #3)
JP10	+5 Volts DC	Output of regulator U2

Note #1 – JP1 can be used for either PTT input for mic encoder operation, or as a relay control output if power control is enabled. When used as a relay output, the pin can provide no more than 15 ma current.

Note #2 – JP4 pulled momentarily to ground will force an immediate transmit.

Note #3 – If JP8 and JP9 are jumpered together, pin 4 on connector X2 (Serial Port) can be used to supply raw voltage (V_{in}) to an external device such as a GPS receiver, or to receive power via a specially wired cable assembly. JP9 and JP10 may be connected to provide regulated 5 volt power on pin 4.

Table 3 – DB9 Female (X1) – Radio Port

Pin	Function
1	Audio Out
2	COR / Squelch Input
3	PTT
4	No Connection
5	Audio In
6	Ground
7	Power in
8	PTT Input
9	No Connection

Table 4 – DB9 Male (X2) – Serial Port

Pin	Function
1	No Connection
2	Data In
3	Data Out
4	V_{ext}
5	Ground
6	No Connection
7	No Connection
8	No Connection
9	No Connection

X2 is wired as DTE to allow connection to a GPS receiver using a standard cable. A null modem cable is required for connection to a computer.

By default, the OpenTracker expects GPS data to be in NMEA-0183 format at 4800 baud.

4. OpenTracker Setup and Operation

a. General

The OpenTracker radio connector, X1, is identical to that used by the Kantronics KPC-3 and the Byonics TinyTrak3. Any cable that was made to interface a radio to either of these devices should work with OpenTracker. BUX Comm provides detailed wiring diagrams and pre-assembled cables for a wide variety of radios at <http://www.packetradio.com/wiring.htm>.

Most handheld radios (with the notable exception of those made by Kenwood) assert PTT by grounding the microphone input. Resistor R3 is used for this purpose. R3 should be omitted when the tracker is used with mobile radios or with handhelds that do not use this method of PTT keying. If the tracker will be used with both mobile and handheld radios, R3 can be installed in the cable used to connect the tracker to the handheld.

The OpenTracker requires 6.7 to 30 volts DC. If R11 and R12 are installed, the OpenTracker can measure and report its voltage input level. However, the measurement range is limited to 6.7 to 15 volts.

Power may be supplied at three points on the OpenTracker board. Most often, it is supplied through pin 7 of the radio connector. It may also be supplied through pin 8 of the expansion header. In addition, if a jumper is installed between pins 8 and 9 of the expansion header, power may be supplied through pin 4 of the data connector.

b. Receive Adjustment

The OpenTracker cannot decode incoming packet data. Instead, it watches for audio energy (voice, data, or static) to avoid transmitting over other stations. The sensitivity of the energy detect is determined by the trimpot labeled 'RX'.

Adjust the squelch on the receiver so that it remains closed under average channel conditions with no signals present. Turn RX potentiometer all the way up so that it remains lighted, and then turn it back down until it stops blinking under quiet channel conditions.

c. Transmit Adjustment

The 'TX' potentiometer sets the unit's transmit audio level. To set this level properly, use another radio to listen to the unit's transmitted packets. Turn the level up slowly until the signal doesn't get any louder, and then turn it back down until it gets noticeably quieter. Continue turning it down for about 1/8 turn after that point. **Proper audio level is critical to ensuring the transmitted packets can be received and decoded.** A transmit audio level set too high will cause clipping in the transmitter, which results in signals that are difficult to decode.

The configuration software also allows adjustment of the audio output level using a slider control. See the software documentation for details.

d. LED Blink Codes

The tracker reports its status through the use of a single LED as follows:

Action	Meaning
Rapid blinking	Channel is in use
Single flash	Received valid GPS fix
Double flash	Received invalid GPS fix. GPS may not be ready
Lit solid	Transmitting or in configuration mode

Note - If the LED is blinking rapidly when the channel is not in use, the receive sensitivity is probably set too high. Adjust the RX trimpot until the LED stops blinking. It should start blinking again when the radio's squelch opens.

e. Configuration Program

The OpenTracker is configured through a Microsoft Windows program available in the download section of the website. Use a standard null-modem cable to connect the device to the PC. The PC does not supply power to the tracker, so it must be powered externally.

Connect the tracker and start the configuration program. The first window displayed allows you to select the COM port that the tracker is connected to.

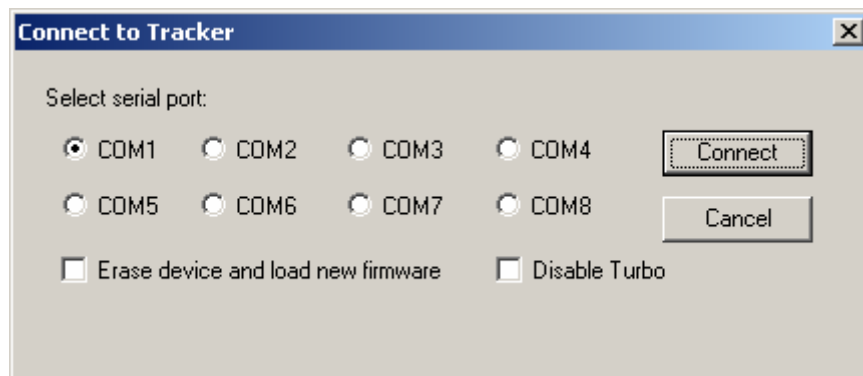

Overwriting an Invalid Configuration

The 'Erase device and load new firmware' option will load a new firmware image, using the default configuration settings, without attempting to read the existing configuration first. This is particularly useful if the tracker has an invalid or missing configuration.

Turbo Mode

By default, the configuration program will attempt to connect at 115,200 baud. If you have trouble connecting, use the 'Disable Turbo' option to force the program to connect at 19,200 baud.

Warm Boot vs. Cold Boot

If the unit is already powered on and operating when you click the 'Connect' button, the program attempts a 'warm boot' operation to put the device into configuration mode. If the firmware has been corrupted, i.e. by a failed upgrade, it may fail to enter configuration mode. You can correct this by performing a 'cold boot' - power the unit off and power it on again after clicking 'Connect'.

f. Main configuration window

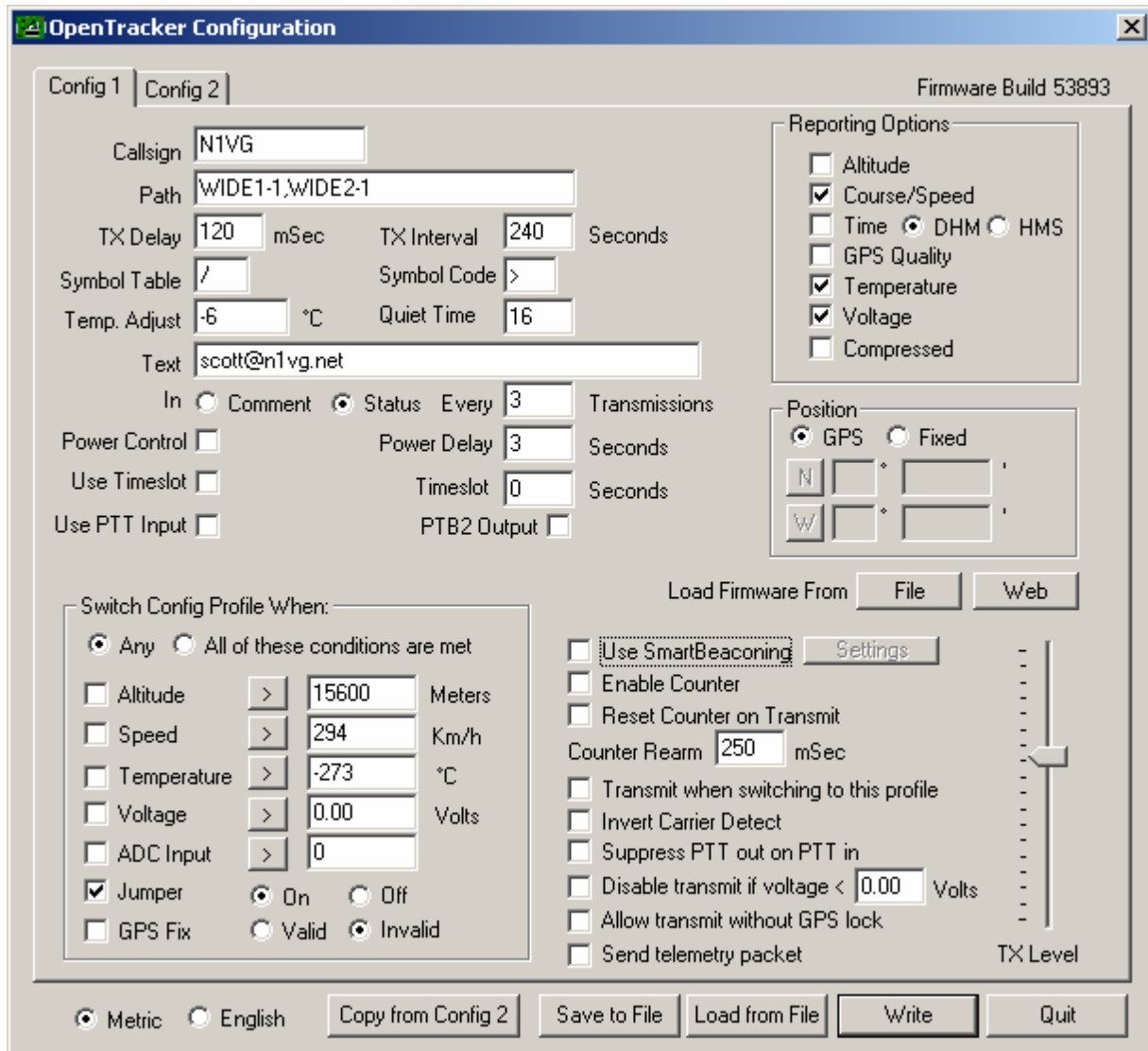

Configuration Profiles

The OpenTracker can store two separate configuration profiles. The profile currently being shown is selected using the tabs at the top of the window labeled 'Config 1' and 'Config 2'.

When it is first powered on, the OpenTracker will always start out using the Config 1 profile. After startup, profile selection depends on the settings in the lower-left pane of the configuration window.

The conditions to test are selected using the checkboxes to the left of each condition. The comparison can be either '>' (greater than) or '<=' (less than or equal to). Clicking on the button showing the comparison operator toggles it between these two settings.

The *Altitude* and *Speed* values are compared with those indicated by the GPS. Onboard sensors provide readings for comparison with the *Temperature* and *Voltage* fields. *ADC Input* refers to the unused analog-to-digital converter input on JP8. The possible values are 0 to 255, corresponding to a range of 0 to 5 volts. The jumper setting refers to JP3. Installing a jumper between pins JP2 and JP3 sets the 'On' condition. The *GPS Fix* is considered invalid if it has been more than 20 seconds since the last valid position was received from the GPS unit.

The selected tests are run once every second. If the conditions are met, the new profile is loaded. If *Transmit when switching to this profile* is checked in the new profile, a packet is transmitted immediately.

Once the switch to the new profile has been made, the criteria in the new profile take effect. **Another switch will not occur until the new criteria are met.** Often, the criteria in each profile will be complementary. For example, Config 1 might indicate a switch when the jumper is installed, and Config 2 would indicate a switch when the jumper is removed. However, the criteria may be completely independent of each other.

If the criteria in both profiles are met at the same time, the configuration will swap every second. Keep in mind that there may be a certain amount of noise or jitter on analog inputs such as voltage and temperature.

Loading and Saving Settings

After changing any configuration options, you must click the 'Write' button to write the changes to the tracker's firmware. You may also use the 'Save to File' button to save the configuration options to a file, which can be loaded later using the 'Load from File' button.

Basic Configuration Options

Callsign – The radio callsign to use when transmitting. Tactical callsigns may be used, but FCC and ITU rules require periodic identification. If the actual callsign is not used here, be sure to include it in the comment field.

Path – This specifies the digipeater path to use. Specific callsigns may be entered (e.g., 'K6SYV-10, K6TZ-10') but for APRS operation a set of common aliases are usually used. A

suggested default path is 'WIDE1-1, WIDE2-1'. It is rarely necessary to use a path greater than WIDE3-3 (requesting three 'wide' digipeater hops), and excessive paths generate large amounts of traffic that degrade the performance of the network. If you're not sure what path should be used for your local area, check with a local digipeater operator. This field may be left blank.

TX Delay – All radios require a certain amount of time to stabilize on their transmitting frequency, and receivers also require time to lock on. This value specifies the number of milliseconds the tracker should wait after the start of the transmission before it begins sending data. Allowable values are 0 to 1023 milliseconds. Setting this value too high will keep the channel busy longer than necessary. Setting it too low will prevent packets from being transmitted properly. Finding the optimum value for your radio may require some experimentation.

TX Interval – How often the tracker should transmit. Allowable values are 0 to 65,535 seconds. This setting will depend on your intended use. One transmission every two minutes is acceptable for most mobile stations. A fixed station (e.g., a solar powered site reporting battery voltage and temperature) might choose an interval in the range of 5 to 30 minutes. If you require transmissions more often than every two minutes or so, consider using the Smart-Beaconing™ options detailed below. Special events with many trackers and short transmission intervals should be operated on a separate frequency, not on the shared APRS channel. An interval of zero will disable timed transmissions.

Symbol Table and **Symbol Code** – These settings control the symbol used to indicate the station's position when drawn on a map. See Appendix B for a listing of available symbols.

Temp. Adjust – Calibration offset for onboard temperature sensor. The sensor used on the OpenTracker is fairly linear across its operating range and requires a single-point calibration. The easiest way to accomplish this is to set a thermometer next to the tracker. Subtract the temperature reported by the tracker from the temperature shown by the thermometer, and enter that value in this field. For example, if the thermometer shows the temperature as 26°C and the tracker reports 29°C, enter -3 for the adjustment value.

Quiet Time – This setting determines how long the channel must be clear before the tracker will transmit. Each unit is approximately 1/56 second. Setting the quiet time to zero causes the tracker to ignore detected traffic.

Text – This is a freeform text field. Anything entered here will be displayed in the comment portion of the transmission or in a separate status packet, as selected. Keep comments as brief as possible to avoid wasting channel capacity, or use the 'Every __ Transmissions' option to reduce how often the text is sent.

Altitude, Course/Speed, Time – When checked, report these values as indicated by the GPS receiver. The timestamp may be in Days/Hours/Minutes or Hours/Minutes/Seconds.

GPS Quality – Report fix type, number of satellites in use, and dilution of precision information as reported by the GPS receiver.

Temperature – Report temperature as indicated by the onboard temperature sensor in the comment field, in degrees C.

Voltage – Report input voltage in the comment field. The maximum value is 15 volts, and the minimum is the dropout voltage of the regulator – typically 6.7 volts.

SmartBeaconing™ – Originally developed for the HamHUD by Tony Arnerich, KD7TA, and Steve Bragg, KA9MVA, the SmartBeaconing™ algorithm allows the tracker to operate more efficiently by changing how often it transmits depending on its speed and direction of travel.

When stopped or moving at a speed below the low speed setting, the tracker will transmit at a fixed rate determined by the lower rate setting. Above the specified high-speed threshold, the higher rate setting is used. Between these two extremes, the interval varies between the low and high rates depending on the speed. A turn angle can also be specified to cause the tracker to transmit when turning.

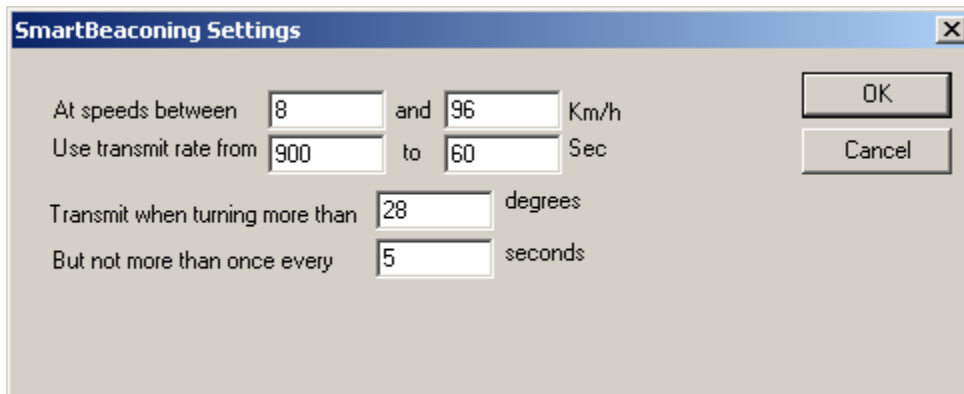

Power Control – When selected, the tracker will assert a 5-volt signal on JP1 before each transmission. This can be used to drive a relay or MOSFET to control power to the transmitter. The tracker will pause for the specified number of seconds to give the transmitter time to power up. The power control feature is especially useful for solar-powered weather or telemetry stations. Do not exceed 25 mA load on JP1.

Timeslot – The timeslot option is typically used to coordinate multiple trackers, especially for special events where many transmitters will be sharing the same channel with a high beacon rate. The number entered selects the timeslot's offset, in seconds, from the start of the hour. The tracker will transmit at this time, and every transmit interval after that. The timeslot value should be smaller than the transmit interval.

Use PTT Input – When this checkbox is enabled, the tracker can be connected inline with a microphone to operate in burst-after-voice mode. A packet will be transmitted whenever the microphone PTT is released.

PTB2 Output – This checkbox controls the output level of pin PTB2 (jumper JP8). Because this pin is shared with the spare ADC input, the checkbox is ignored if the ADC input is used. The output can be used as an indication of the configuration profile currently in use.

Enable Counter – This checkbox enables the digital counter function. When this function is enabled, the tracker will no longer transmit immediately when JP4 is shorted to ground. Instead, it will increment a counter and include the current count in the status text, e.g., 'CNT00001'. The maximum count is 65535, after which the counter rolls over to zero.

Reset Counter on Transmit – Setting this checkbox causes the counter to reset with every transmission. Hence, the count reported is the number of events since the last transmission.

Counter Rearm – This is a 'debounce' delay applied to the counter input. After a counter event is registered, all subsequent events are ignored until the specified time has elapsed.

Invert Carrier Detect – Usually used with mobile radios, this checkbox indicates that the channel is busy when the carrier detect input is low.

Suppress PTT Out on PTT In – This option allows the tracker to be used in burst-after-voice mode without breaking any lines between the microphone and radio. PTT is not asserted by the tracker until the microphone PTT is released.

Disable Transmit on Low Voltage – To avoid over-discharging batteries, enable this option and enter the minimum voltage at which the tracker should operate the transmitter.

Allow Transmit Without GPS Lock – Normally, while in GPS mode, the tracker will not transmit without a valid fix. When this option is selected, the tracker will continue to transmit its last known position if GPS lock is lost for more than 30 seconds. This condition is indicated by the text 'NOFIX' in the status message. If the tracker has received no valid fix since startup, no position will be reported. Status text and telemetry packets will be unaffected. This option is particularly useful for applications like high altitude balloons that may lose GPS lock after landing, but still need to transmit to be found.

Send Telemetry Packet – Enabling this option causes the tracker to transmit a standard APRS telemetry packet after each position packet. The telemetry packet contains raw readings from the three analog-to-digital converter inputs, the low eight bits of the counter, the GPS HDOP reading, the profile in use, and the status of the jumper input.

TX Level – This slider sets the audio output level. It is functionally similar to the ‘TX’ potentiometer on the board, but allows different audio levels to be set for each profile.

Copy from Config n – This button copies the contents of one profile to the other. Be sure to check the profile switching options in the lower left pane if you use this feature – having the same criteria here in both profiles is usually not desired.

5. Installing New Firmware

New firmware for the OpenTracker is frequently released to provide new features, fix bugs, or even completely change the nature of the device – from a GPS-connected tracker to a remote weather station or CW keyer, for example.

Two methods are provided to install new firmware images. First, the files may be downloaded from the website manually and uploaded to the device using the ‘File’ button. This is particularly useful if you will be configuring devices on a computer without Internet access. Second, by clicking on the ‘Web’ button, the configuration program will retrieve a list of currently available firmware images. Selecting one of these will automatically download the file from the website and upload it to the device.

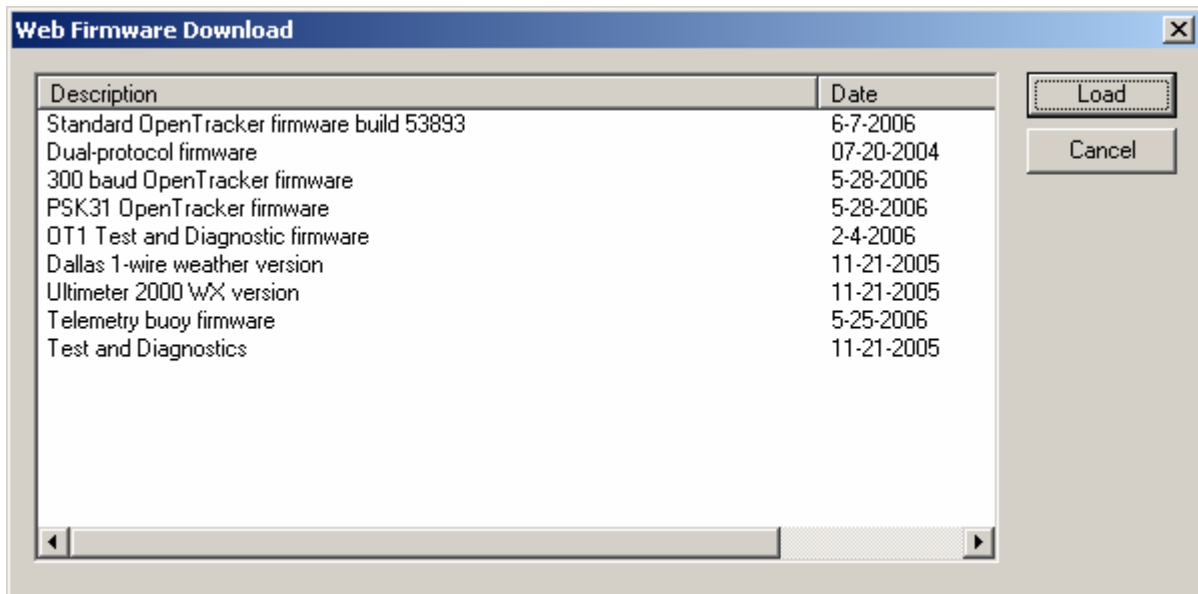

Firmware files are in Motorola S19 format. If you compile your own firmware, the S19 file generated by the linker can be used without modification. Interrupt vectors are automatically rewritten by the configuration program.

6. Weather Station Operation

Connecting to a Weather Station

The OpenTracker can be used with the 1-Wire Weather Instrument from AAG Electronica, the Peet Bros. Ultimeter II, and the Peet Bros. Ultimeter 2000 series weather stations, including the Ultimeter 800 and 2100. In Dallas/1-Wire mode, the microcontroller's PTB2 line is used as the 1-wire data bus. This signal is available at pin 7 of the 10-pin header. A pull-up resistor, connected to the 5-volt supply, is required for the 1-wire bus to function properly. All other weather stations connect to the serial port.

Weather Firmware Setup

If the OpenTracker has the weather station firmware loaded, the configuration program will detect this and display a different screen on startup. Most of the options function as with the standard tracker firmware. However, the weather station operates only in fixed position mode – it cannot interface with a GPS receiver. Also, the comment text is always sent in a separate packet from the weather data.

The 'Wind Vane Adjust' slider is used to calibrate the 1-wire weather station's wind vane. The wind vane should be pointed in a known direction and the slider adjusted until the direction is reported properly. Peet Bros. stations should be configured in 'complete' data mode.

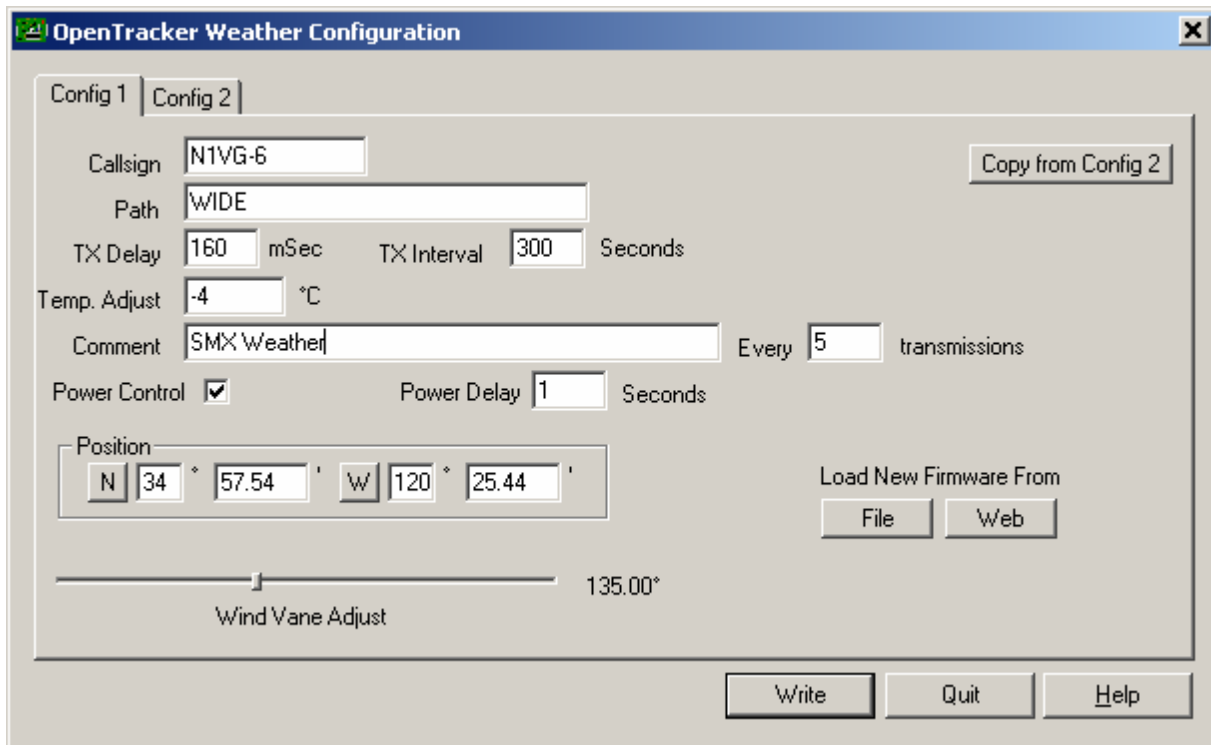

7. Telemetry Operation

With the telemetry option enabled, the OpenTracker will transmit an APRS-formatted telemetry packet after each position packet:

```
T#011,155,218,000,000,000,00000000
```

Six three-digit fields follow the 'T#' header. Each field has a range of zero to 255. The fields are interpreted as follows:

Sequence number: Incremented with each transmission.

ADC0: Multiply by 1.9608 for temperature reading in kelvins.

ADC1: Divide by 17 for supply voltage reading in volts.

ADC2: Divide by 51 for auxiliary analog input reading in volts.

Counter: Low eight bits of the digital counter input.

HDOP: Divide by 10 for GPS horizontal dilution of precision reading.

Of the final eight-digit field, only two binary digits are used – the rightmost bit reflects the jumper input, and the next bit indicates the configuration profile in use.

8. OpenTracker Circuit Details

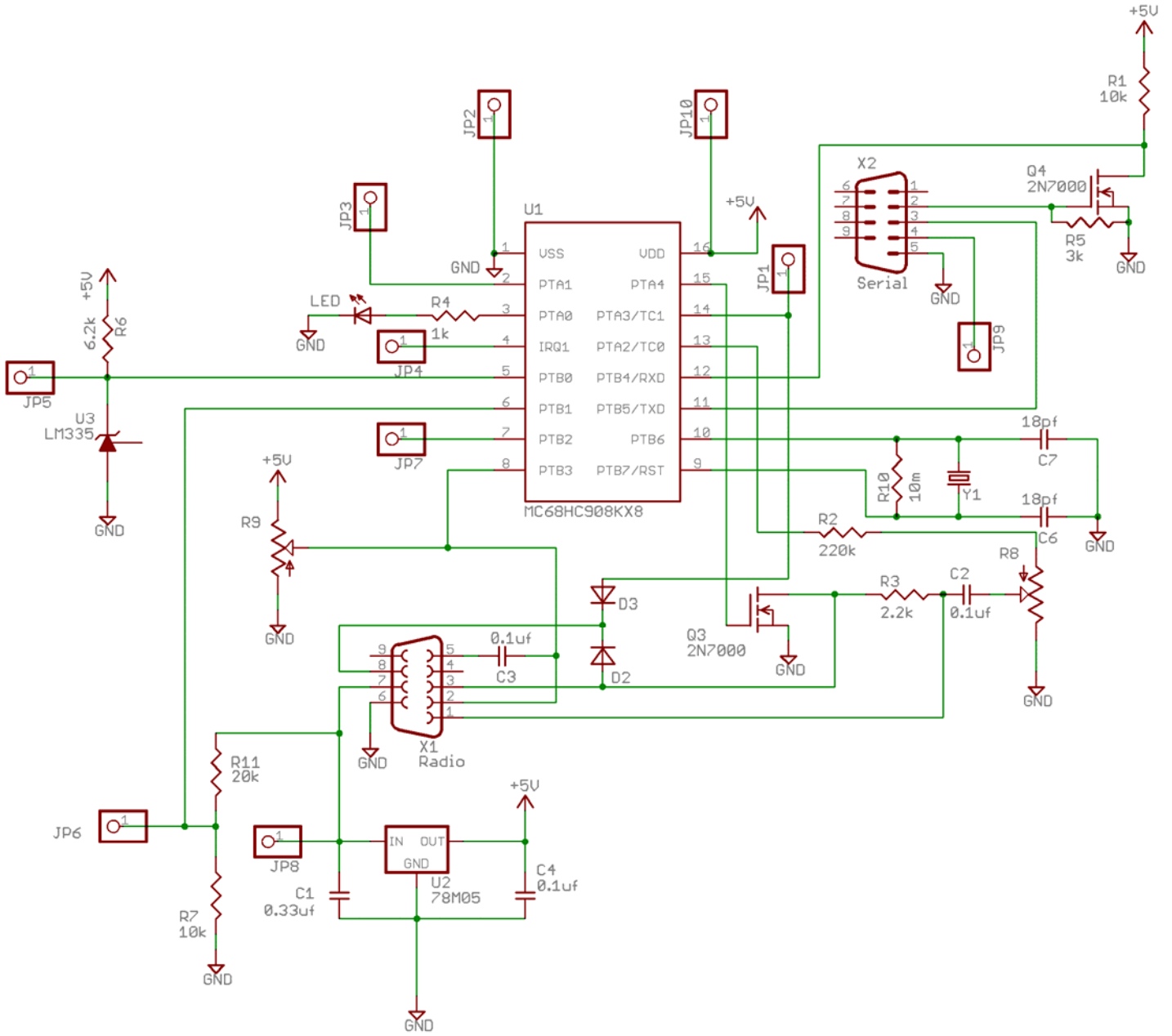

Theory of Operation

The heart of the OpenTracker circuit is a Freescale MC908KX8 microcontroller unit (MCU). The MCU contains 192 bytes of RAM and roughly 8 kilobytes of Flash program memory. It runs at a clock speed of 7.3728 MHz.

U2 is a linear voltage regulator that provides regulated 5 VDC power to the circuit, and optionally to an external device connected to V_{ext} . C1 and C2 are the input and output filter capacitors, respectively.

Y1, C6, C7, and R10 form the clock oscillator circuit. The oscillator frequency of 29.4912 MHz is divided by four in the MCU's clock module to produce the bus clock signal.

Audio output originates at pin 13 of the MCU. This pin is configured as a timer channel output and generates a pulse-width modulated signal between 0 and 5 volts. Audio tones are generated in software using a sine wave lookup table. R2 and R8 limit the audio output level, and C2 couples the AC component of the signal to the audio output at X1 pin 1.

Pin 15 of the MCU produces the PTT output signal. It switches Q3, pulling the audio output down through R3 for handheld PTT, and pulling X1 pin 3 to ground for other radios.

An externally applied PTT signal on X1 pin 8 will pull the PTT output low through D2, and will pull pin 14 of the MCU low (it is normally held high by an internal pull-up resistor) through D3.

The audio input from the radio is AC-coupled by C3 and biased by R9. R9 sets the carrier detect threshold. X1 pin 2 provides a DC-coupled input for radios with a squelch or carrier operated relay output.

R5, R1, and Q4 form an inverter/buffer circuit for the RS-232 input. The RS-232 output polarity is controlled in software. The output level swings between 0 and 5 volts, and may not be compatible with all RS-232 devices.

U3 is a temperature sensor with an output of 10 mV per Kelvin. R6 limits its input current, and its output drives one of the analog inputs on the MCU.

R7 and R11 form a voltage divider, the output of which is one third of the supply voltage. This voltage drives another analog input on the MCU.

The LED is driven by a high-current output line from the MCU, through current limiting resistor R4. Lowering the value of R4 will increase the brightness of the LED.

9. Assembly Notes Pictorial



1. Inventory and separate parts for easier handling during assembly



2. Start with microprocessor socket and 10-pin header

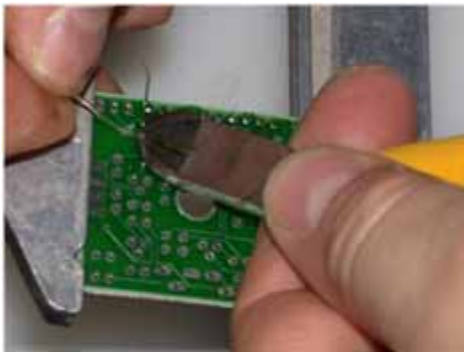

3. Solder a few parts, solder, and then clip off leads close. Look for bridges and shorts as you go along.



4. Close-up of C6, Y1, C7 – note how inserting Y1 might be tricky if C6 and C7 are both already in place



5. Finished project. In this case R3 has been left out as this unit will be used with a mobile rig

Appendix A – Test Procedures

a. Measurements

Disconnect the tracker, remove U1 from its socket, and use an ohmmeter to check the following connections. Nominal values are approximate.

Connection	Nominal Value	Circuit Description
U1-1 to U1-16	2.6 k Ω	Power to Ground
U1-9 to U1-10	10 M Ω	Crystal oscillator
R8 outer leads	10 k Ω	TX level adjust pot
JP2 to JP8	30 k Ω	Voltage divider
U1-5 to U1-1	7.5 k Ω	Temperature sensor

With U1 removed, connect the tracker to its power source. Using U1 pin 1 or JP2 as ground, check the following voltages.

Connection	Nominal Value	Circuit Description
U1 pin 16	5 V \pm 0.25	Voltage regulator output
U1 pin 5	10 mV / K	Temperature sensor: 2.95 V = 295 Kelvin = 71.3 °F
JP8	6.7 to 35 V	V _{in}
U1 pin 6	1/3 V _{in}	Voltage divider

Remove power, re-install U1, and power up the tracker. With a typical digital voltmeter, U1 pins 9 and 10 should indicate approximately 2.4 V and 2.2 V, respectively. A frequency counter or oscilloscope should show a 29.4912 MHz signal at these pins. Absence of this signal indicates a problem with U1 or the crystal oscillator.

Appendix B – APRS symbol tables

APRS symbols are identified by a single character, and may be chosen from either the primary or alternate table. Additionally, some of the symbols from the alternate table may be overlaid with an alphanumeric character by substituting the character to be overlaid (0-9, a-z, or A-Z) in place of the '\ ' table designator.

Symbol	Primary Table (/)	Alternate Table (\)
!	Police Station	Emergency
"	<Reserved>	<Reserved>
#	Digipeater	Digipeater w/ overlay
\$	Phone	Bank or ATM
%	DX Cluster	<Reserved>
&	HF Gateway	Diamond w/ overlay
'	Small Aircraft	Crash site
(Mobile Sat Station	Cloudy
)	Wheel Chair	MODIS Earth Observation
*	Snowmobile	Snow
+	Red Cross	Church
,	Boy Scouts	Girl Scouts
-	House (VHF)	House (HF)
.	X	Question Mark
/	Red Dot	Destination (Red Dot)
0	Circle <Obsolete>	Circle w/ overlay
9	<Obsolete>	Gas/Petrol Station
:	Fire	Hail
;	Campground	Park or Picnic Area
<	Motorcycle	Advisory
=	Railroad Engine	<Reserved>
>	Car	Car w/ overlay
?	File server	Info Kiosk
@	Hurricane Prediction	Hurricane / Tropical Storm
A	Aid Station	Box w/ overlay
B	BBS	Blowing snow
C	Canoe	Coast Guard
D	<Reserved>	Drizzle
E	Eyeball	Smoke
F	Farm Vehicle (tractor)	Freezing Rain
G	Grid Square	Snow Shower
H	Hotel	Haze
I	TCP/IP	Rain Shower
J	<Reserved>	Lightning
K	School	Kenwood
L	Logged-On User	Lighthouse
M	MacAPRS	<Reserved>
N	NTS Station	Navigation Buoy

O	Balloon	Rocket
P	Police	Parking
Q	<Reserved>	Quake
R	Rec. Vehicle	Restaurant
S	Shuttle	Satellite
T	SSTV	Thunderstorm
U	Bus	Sunny
V	ATV	VORTAC
W	NWS Site	NWS Site w/ overlay
X	Helicopter	Pharmacy
Y	Yacht	<Reserved>
Z	WinAPRS	<Reserved>
[Jogger	Wall Cloud
\	Triangle	<Reserved>
]	PBBS	<Reserved>
^	Large Aircraft	Aircraft w/ overlay
_	WX Station	WX Station w/ overlay
`	Dish Antenna	Rain
a	Ambulance	ARES
b	Bike	Blowing Dust/Sand
c	ICP	Civil Defense w/ overlay
d	Fire Station	DX Spot
e	Horse	Sleet
f	Fire Truck	Funnel Cloud
g	Glider	Gale
h	Hospital	HAM store
i	IOTA	Indoor BOXn digi w/overlay
j	Jeep	Work Zone
k	Truck	SUV (off-roader, 4x4)
l	Laptop	Area Locations
m	Repeater	Signpost (3-digit)
n	Node	Triangle w/ overlay
o	EOC	Small Circle
p	Rover	Partly Cloudy
q	Grid square	<Reserved>
r	Antenna	Restrooms
s	Ship / Power Boat	Boat w/ overlay
t	Truck Stop	Tornado
u	Truck (18 wheeler)	Truck w/ overlay
v	Van	Van w/ overlay
w	Water Station	Flooding
x	xAPRS	<Reserved>
y	Yagi	Skywarn
z	Shelter	Shelter w/ overlay
{	<Reserved>	Fog

Appendix C – Common Modifications

Extended Audio Level Range

When to use: Use this modification when the audio drive level cannot be set high enough for your radio.

Explanation: The OpenTracker is normally supplied with a conservative value for R2 to reduce the possibility of overdeviation and distortion. For a minority of radios, this results in an audio level that is too low.

Procedure: Replace R2 with a lower value resistor. Halving the value of R2 doubles the audio level adjustment range.

PTT Signal Method

When to use: Use this modification when the OpenTracker is used with most mobile radios and certain handhelds.

Explanation: Most handheld radios signal push-to-talk by pulling the microphone input to ground through a known impedance. R3 normally serves this purpose in the OpenTracker. It is not required for mobile radios and certain handhelds, most notably those made by Kenwood, and may cause them to transmit continuously if installed.

Procedure: Omit R3. For certain types of handhelds, especially commercial models (e.g., Motorola GP-68) it may be necessary to use a lower value for R3.